

REAR LOADING CONTAINERS – 2 WHEELS

80 Litres

80 L

Capacity

40 Kg

Nominal load

200 mm

Wheels diameter



TECHNICAL SPECIFICATIONS

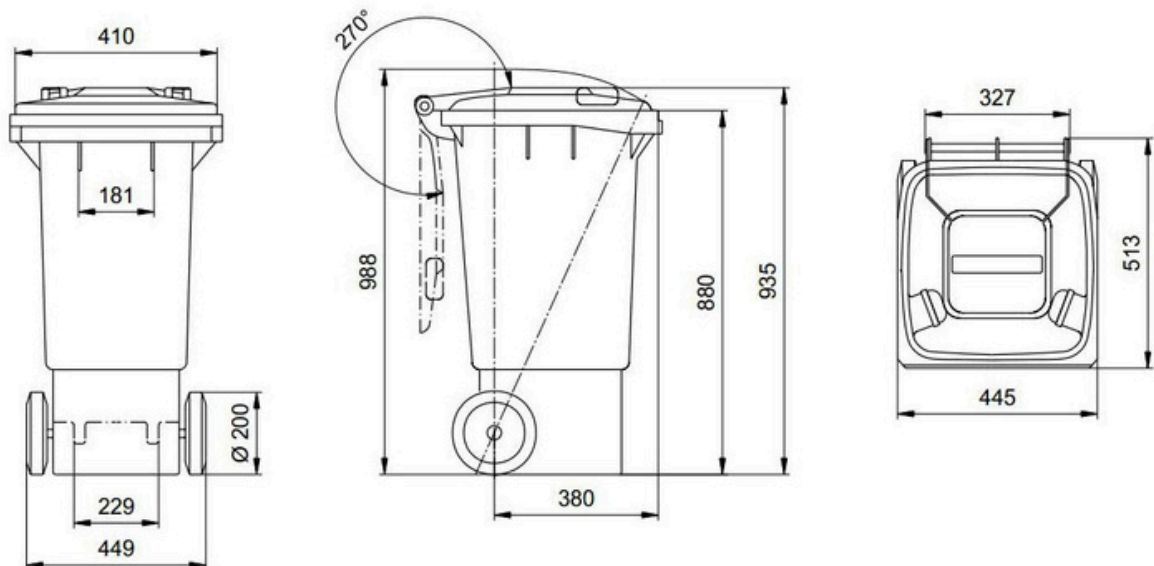

MGB 80 L

REAR LOADING CONTAINERS – 2 WHEELS

80

FEATURES

- Manufactured and tested to EN840 - DIN30700. (EN840 is the Europe wide standard for emptying interoperability and handling safety).
- Extra strength comb lift bar.
- Made from HDPE (High –density Polyethylene) for extra strength and life.
- Full thickness “flat body” design (Some other bins,with“fluted bodies” that are much thinner, won't last as long).
- Maximum strength additives for resistance to UV, cold, heat and chemicals (No corners cut).
- Solid steel galvanised wheel axle with solid wheel tyres.
- Certified compliant with EU noise protection directive.
- 100% recyclable at end of life.

EQUIPMENT AND ACCESSORIES

- Stepped comb-lift, reinforced with ribs, for maximum safety when emptying the waste recycling bins.
- Fitted with 200 mm diameter solid, quiet-running rubber wheels.
- Lid with drip edges minimises the escape of condensation water

STANDARDS

- Complies with the noise control regulation in accordance with EC directive 2000/14/EC and is marked with the appropriate noise level
- Manufactured in accordance with DIN EN 840 and RAL GZ 951/1

